

# HAEMOSTATIC FORCEPS



# HAEMOSTATIC FORCEPS

Arterienklemmen

Pinzas Hemostaticas

Pinces Hemostatiques

Pinze Emostatiche



**Mosquito Haemostatic Forceps**

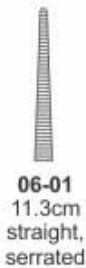

**06-01**  
11.3cm  
straight,  
serrated

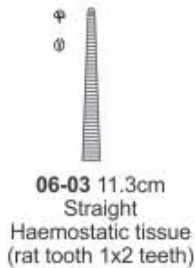

**06-03** 11.3cm  
Straight  
Haemostatic tissue  
(rat tooth 1x2 teeth)



**06-02**  
11.3cm  
Curved,  
Serrated



**06-04** 11.3cm  
Curved  
Haemostatic tissue  
(rat tooth 1x2 teeth)



**Halsted-Mosquito Haemostatic Forceps**



**06-05**  
12.5cm  
**06-06**  
20cm  
straight



**06-07**  
12.5cm  
**06-08**  
20cm  
curved



**Halsted-Mosquito Haemostatic Forceps**



**06-09**  
12.5cm  
**06-10**  
20cm  
straight  
Left Handed



**06-11**  
12.5cm  
**06-12**  
20cm  
curved  
Left Handed



**Kelly Haemostatic Forceps**



**06-13**  
14cm  
straight



**06-15**  
Kelly Haemostatic Fine  
point Forceps 14cm  
straight



**06-14**  
14cm  
curved



**06-16**  
Kelly Haemostatic Fine  
point Forceps 14cm  
curved

**HAEMOSTATIC FORCEPS**

Arterienklemmen

Pinzas Hemostaticas

Pinces Hemostatiques

Pinze Emostatiche



**Dandy Haemostatic  
Fine point Forceps**  
06-18 14cm  
Curved sideways



**Dandy Haemostatic Fine  
point Tissue Forceps**  
06-20 14cm  
(rat tooth 1x2 teeth)  
Curved sideways

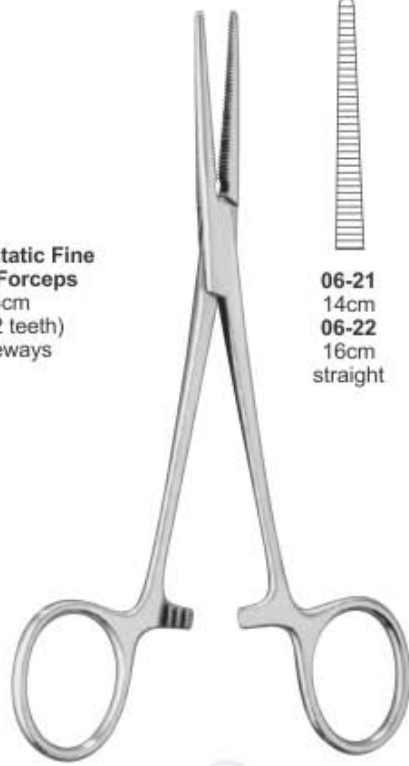

**06-21**  
14cm  
**06-22**  
16cm  
straight

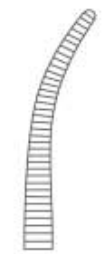

**06-23**  
14cm  
**06-24**  
16cm  
curved

**Dandy Haemostatic Forceps**  
06-17 14cm  
Curved sideways

**Dandy Haemostatic  
Tissue Forceps**  
06-19 14cm  
(rat tooth 1x2 teeth)  
Curved sideways

**Crile Haemostatic Forceps**

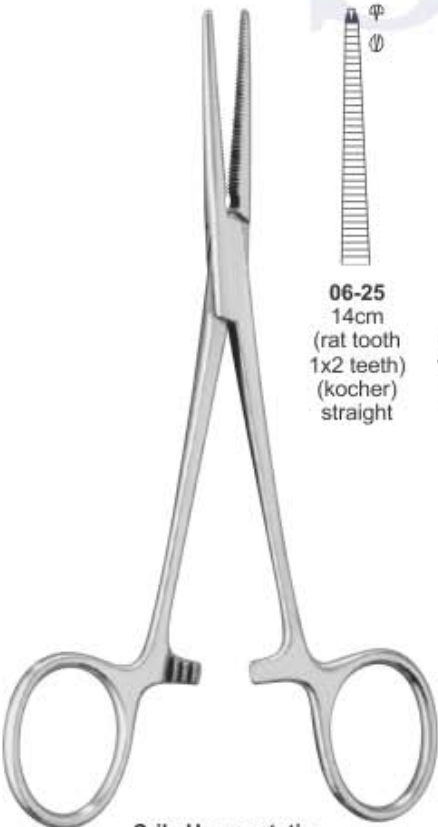

**06-25**  
14cm  
(rat tooth  
1x2 teeth)  
(kocher)  
straight



**06-26**  
14cm  
(rat tooth  
1x2 teeth)  
(kocher)  
curved

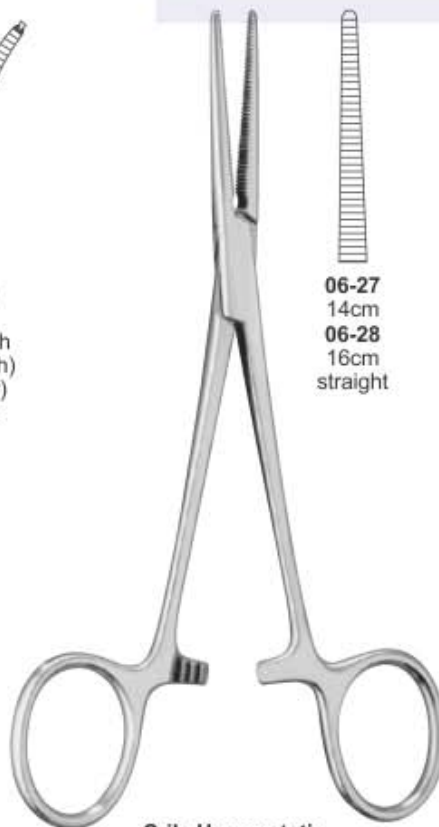

**06-27**  
14cm  
**06-28**  
16cm  
straight



**06-29**  
14cm  
**06-30**  
16cm  
curved

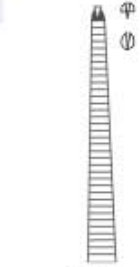

**06-31**  
14cm  
straight  
(rat tooth  
1x2 teeth)  
Crile Haemostatic  
Fine Point  
Tissue Forceps



**06-32**  
14cm  
curved  
(rat tooth  
1x2 teeth)  
Crile Haemostatic  
Fine Point  
Tissue Forceps

**Crile Haemostatic  
Tissue Forceps**

**Crile Haemostatic  
Fine Point Forceps**

Arterienklemmen  
Pinces Hemostatiques

Pinzas Hemostaticas  
Pinze Emostatiche

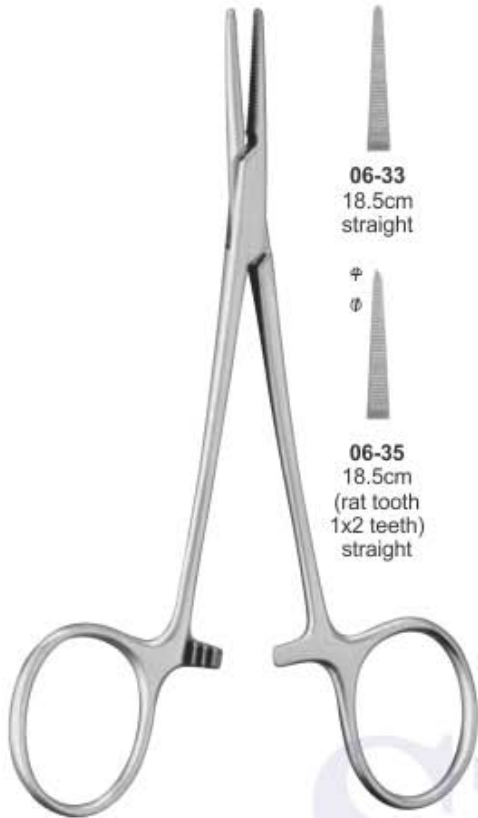

**06-33**  
18.5cm  
straight



**06-35**  
18.5cm  
(rat tooth  
1x2 teeth)  
straight

**06-34**  
18.5cm  
curved



**06-36**  
18.5cm  
(rat tooth  
1x2 teeth)  
curved

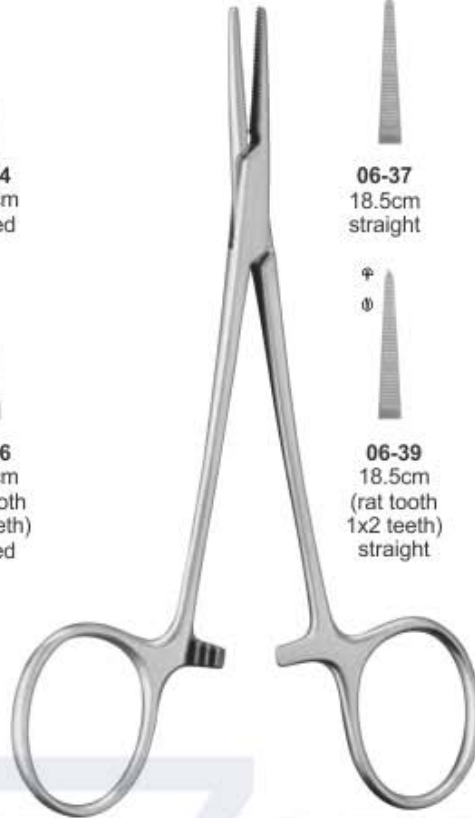

**06-37**  
18.5cm  
straight



**06-39**  
18.5cm  
(rat tooth  
1x2 teeth)  
straight

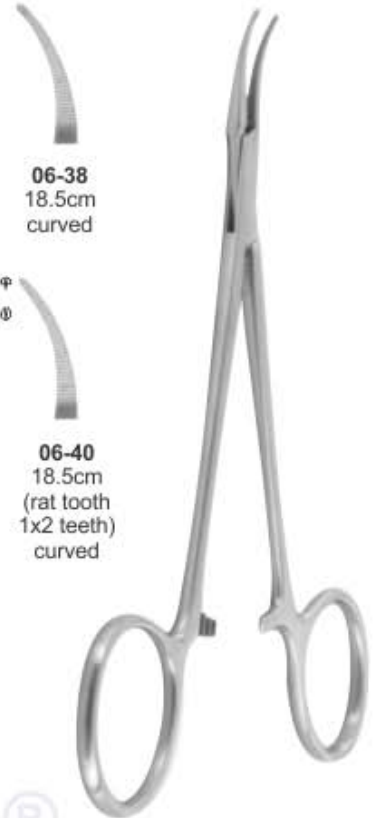

**06-38**  
18.5cm  
curved



**06-40**  
18.5cm  
(rat tooth  
1x2 teeth)  
curved

**Halsted Haemostatic Forceps**

**Halsted Haemostatic Fine point Forceps**

**Packer Mosquito Forceps**  
**06-41** 12.7cm  
Curved, flat jaws

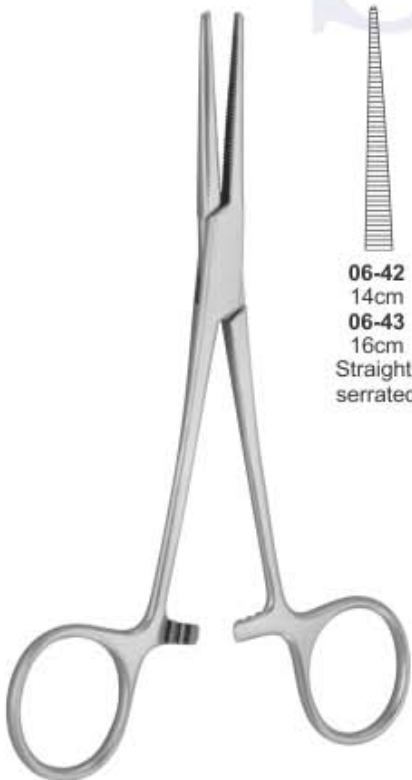

**06-42**  
14cm  
**06-43**  
16cm  
Straight,  
serrated

**06-44**  
14cm  
**06-45**  
16cm  
Curved,  
serrated

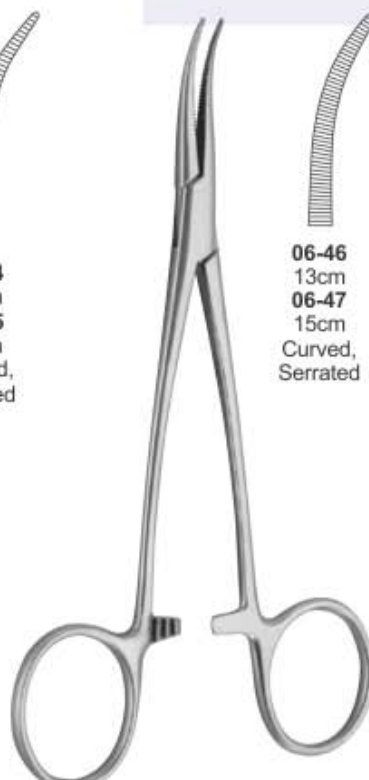

**06-46**  
13cm  
**06-47**  
15cm  
Curved,  
Serrated



**06-48**  
24cm  
Straight,  
Serrated

**06-49**  
24cm  
Curved  
Serrated

**Coller Haemostatic Forceps**

**Christophe Haemostatic Forceps**

**Saroot Haemostatic Forceps**

Arterienklemmen

Pinzas Hemostaticas

Pinces Hemostatiques

Pinze Emostatiche



**06-50**  
18.5cm  
straight

**06-51**  
18.5cm  
curved

Adson Haemostatic Fine point Forceps



**06-52**  
18.5cm  
straight  
(rat tooth  
1x2 teeth)

**06-53**  
18.5cm  
Curved  
(rat tooth  
1x2 teeth)

Adson Haemostatic Tissue Forceps



**06-54**  
15cm  
**06-55**  
20cm  
Curved

**06-56**  
15cm  
**06-57**  
20cm  
Curved  
Fine Point

O'Shaughnessy Haemostatic Forceps



**06-58** 14.5cm  
Straight,  
box joint, as  
above but  
curved on flat.

Cairns Haemostatic Forceps



**06-59**  
13cm  
**06-60**  
14cm  
straight

**06-61**  
13cm  
**06-62**  
14cm  
curved

Pean Haemostatic Forceps Slender Type



**06-63**  
14.5cm  
Straight

Kocher Haemostatic Forceps Strong Pattern

Arterienklemmen  
Pinces Hemostatiques

Pinzas Hemostaticas  
Pinze Emostatiche

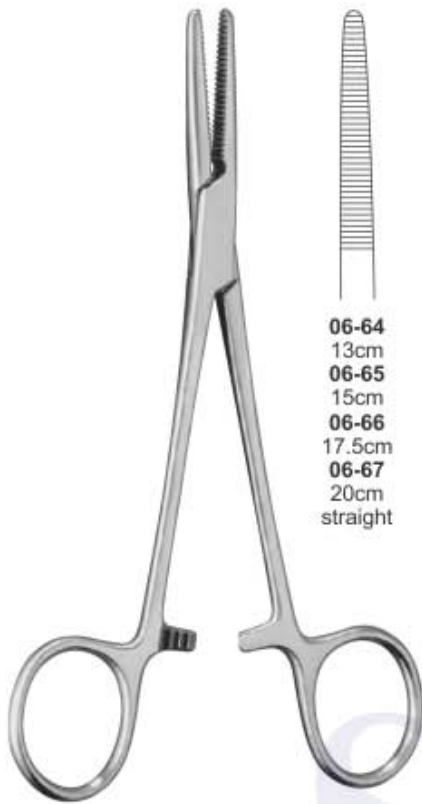

**06-64**  
13cm  
**06-65**  
15cm  
**06-66**  
17.5cm  
**06-67**  
20cm  
straight

**06-68**  
13cm  
**06-69**  
15cm  
**06-70**  
17.5cm  
**06-71**  
20cm  
curved

**Spencer-Wells Haemostatic Forceps  
Slender Type**

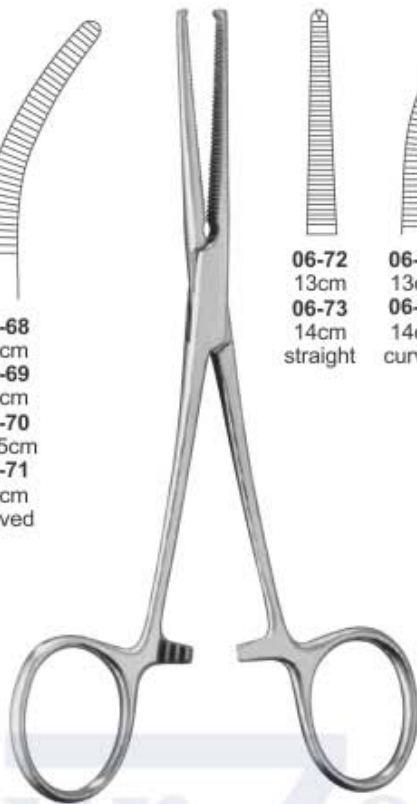

**06-72**  
13cm  
**06-73**  
14cm  
straight

**06-74**  
13cm  
**06-75**  
14cm  
curved

**Kocher Haemostatic Forceps  
1x2 teeth**

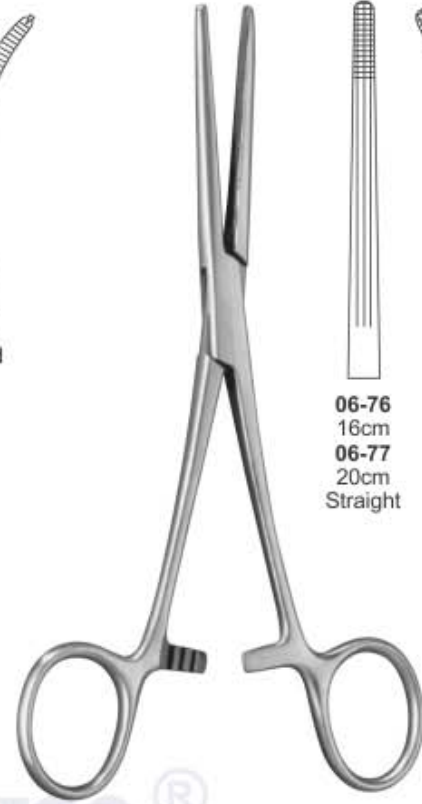

**06-76**  
16cm  
**06-77**  
20cm  
Straight

**06-78**  
16cm  
**06-79**  
20cm  
Curved

**Rochester-Carmalt Haemostatic  
Forceps**

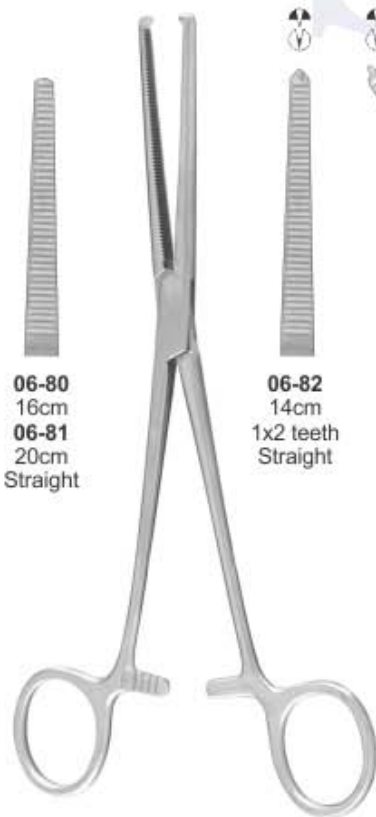

**06-80**  
16cm  
**06-81**  
20cm  
Straight

**06-82**  
14cm  
1x2 teeth  
Straight

**06-83**  
14cm  
1x2 teeth  
Curved

**Rochester-Ochsner  
Haemostatic Forceps**

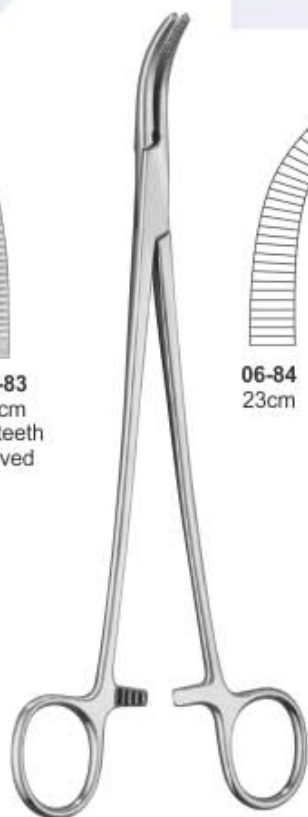

**06-84**  
23cm

**06-85**  
24cm

**Moynihan Haemostatic Forceps**



**06-86**  
19.5cm

**06-87**  
19.5cm

**Negus Haemostatic Forceps**

Arterienklemmen

Pinzas Hemostaticas

Pinces Hemostatiques

Pinze Emostatiche



- 06-88 14cm
- 06-89 16cm
- 06-90 18.5cm
- 06-91 20cm
- 06-92 22.5cm
- 06-93 24cm
- 06-94 25.4cm
- 06-95 28cm
- 06-96 30.5cm
- 06-97 35.6cm
- 06-98 40.5cm
- 06-99 45.5cm
- 06-100 50.8cm
- 06-101 55.6cm
- 06-102 60cm straight

Rochester-Pean Haemostatic Forceps Straight

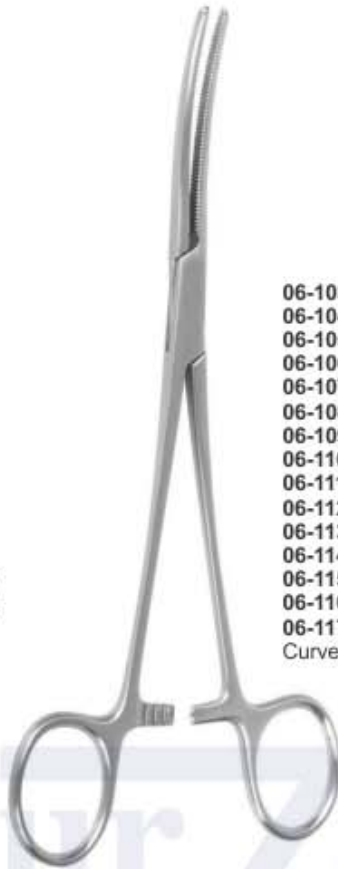

- 06-103 14cm
- 06-104 16cm
- 06-105 18.5cm
- 06-106 20cm
- 06-107 22.5cm
- 06-108 24cm
- 06-109 25.4cm
- 06-110 28cm
- 06-111 30.5cm
- 06-112 35.6cm
- 06-113 40.5cm
- 06-114 45.5cm
- 06-115 50.8cm
- 06-116 55.6cm
- 06-117 60cm Curved

Rochester-Pean Haemostatic Forceps Curved

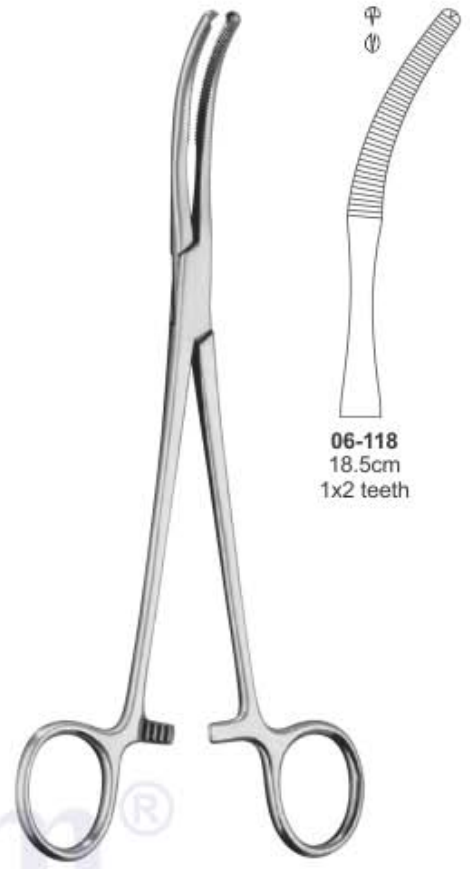

- 06-118 18.5cm 1x2 teeth

Mikulicz Haemostatic Tissue Forceps



- 06-119 16cm
- 06-120 18.5cm
- 06-121 20cm
- 06-122 22.5cm
- 06-123 24cm
- 06-124 26cm Straight 1x2 teeth

Kocher-Ochsner Haemostatic Forceps 1x2 teeth

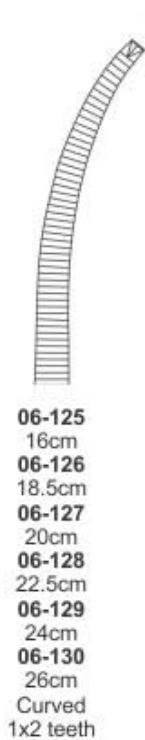

- 06-125 16cm
- 06-126 18.5cm
- 06-127 20cm
- 06-128 22.5cm
- 06-129 24cm
- 06-130 26cm Curved 1x2 teeth

Rochester-Ochsner Haemostatic Forceps 1x2 teeth



- 06-131 14cm
- 06-132 15cm
- 06-133 16cm
- 06-134 18cm
- 06-135 20cm
- 06-136 22cm
- 06-137 24cm
- 06-138 26cm
- 06-139 28cm
- 06-140 25cm

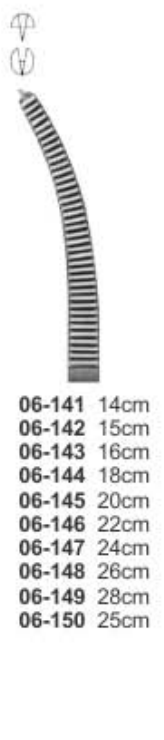

- 06-141 14cm
- 06-142 15cm
- 06-143 16cm
- 06-144 18cm
- 06-145 20cm
- 06-146 22cm
- 06-147 24cm
- 06-148 26cm
- 06-149 28cm
- 06-150 25cm

Arterienklemmen  
Pinces Hemostatiques

Pinzas Hemostaticas  
Pinze Emostatiche



**06-151**  
Serrated  
21.5cm

**06-152**  
1x2 teeth  
21.5cm

Halsted Haemostatic Forceps

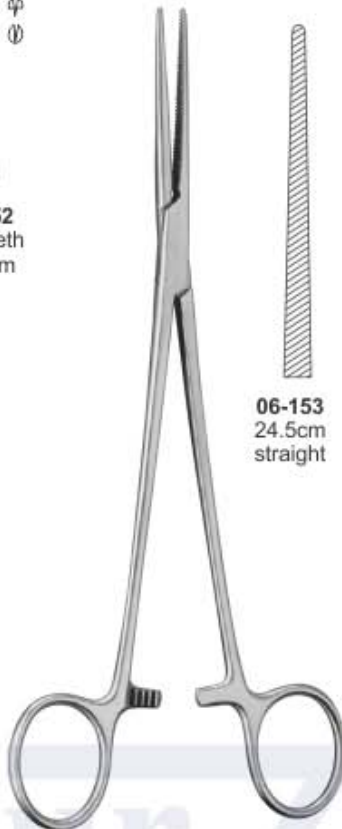

**06-153**  
24.5cm  
straight

**06-154**  
24.5cm  
Curved

Bengolea Haemostatic Forceps

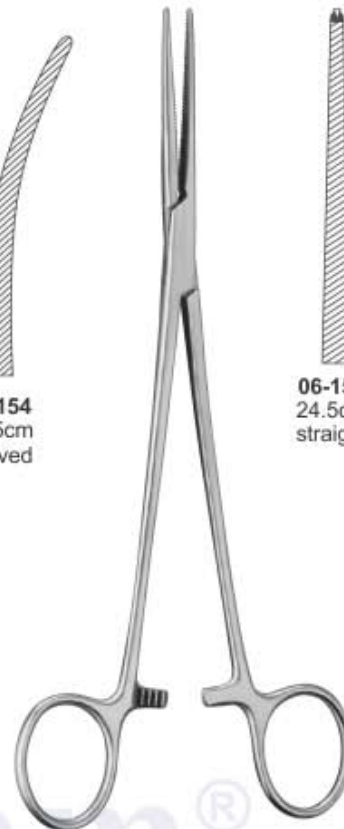

**06-155**  
24.5cm  
straight

**06-156**  
24.5cm  
Curved

Bengolea Haemostatic Tissue Forceps  
(rat tooth 1x2 teeth)



**06-157** 14cm  
**06-158** 16.5cm  
**06-159** 19cm  
**06-160** 21.5cm  
**06-161** 24cm

Mixer-O'Shaugnessy  
Haemostatic Forceps

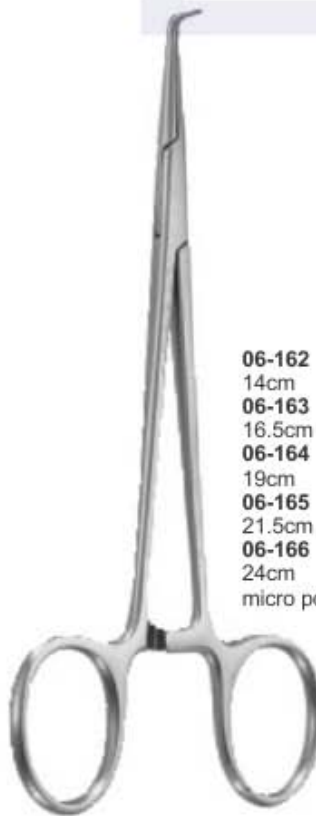

**06-162**  
14cm  
**06-163**  
16.5cm  
**06-164**  
19cm  
**06-165**  
21.5cm  
**06-166**  
24cm  
micro point

Mixer-O'Shaugnessy  
Haemostatic Forceps

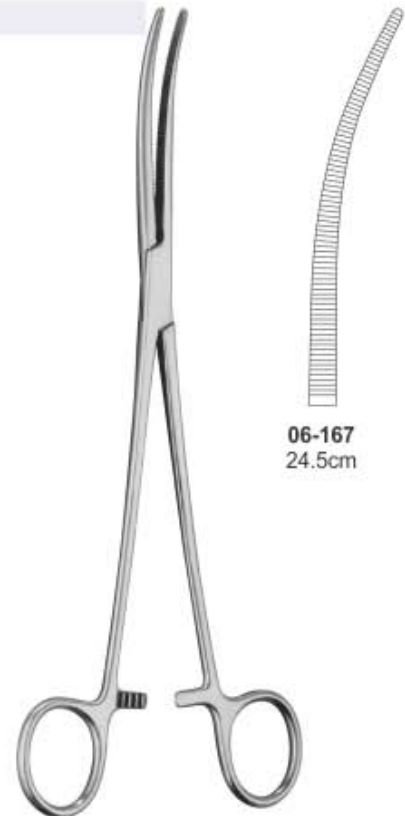

**06-167**  
24.5cm

Craford Haemostatic Forceps



**HAEMOSTATIC FORCEPS**

Arterienklemmen

Pinzas Hemostaticas

Pinces Hemostatiques

Pinze Emostatiche



**Herrick Haemostatic Forceps**  
06-168 23cm

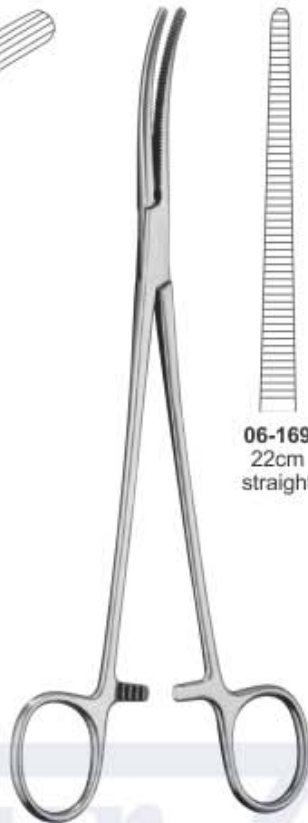

**Roberts Haemostatic Forceps**

**06-169**  
22cm  
straight

**06-170**  
22cm  
Curved

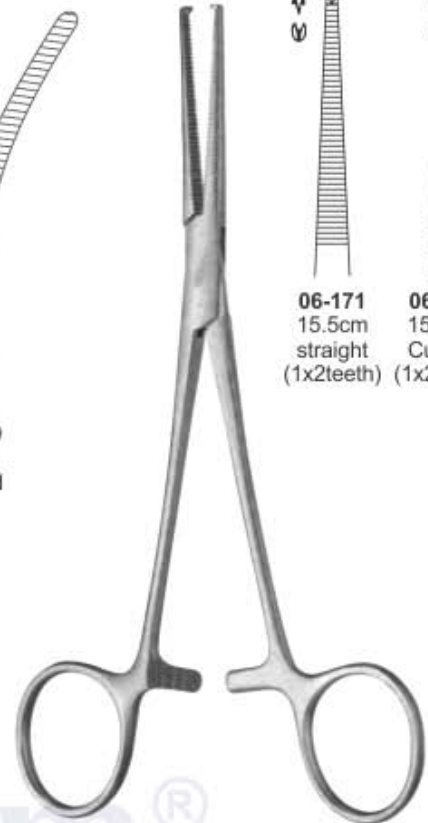

**Dixon-Lovelace Haemostatic Tissue Forceps**

**06-171**  
15.5cm  
straight  
(1x2teeth)

**06-172**  
15.5cm  
Curved  
(1x2teeth)



**Crafoord-Sellors Haemostatic Forceps**

**06-173**  
22cm

**06-174**  
23cm

**06-175**  
24cm



**Heaney / Ballantine Haemostatic Forceps**

**06-176**  
20cm  
Straight,  
Serrated

**06-177**  
20cm  
Slight Curve,  
Serrated

# HAEMOSTATIC FORCEPS

Arterienklemmen  
Pincas Hemostatiques

Pinzas Hemostaticas  
Pinze Emostatiche

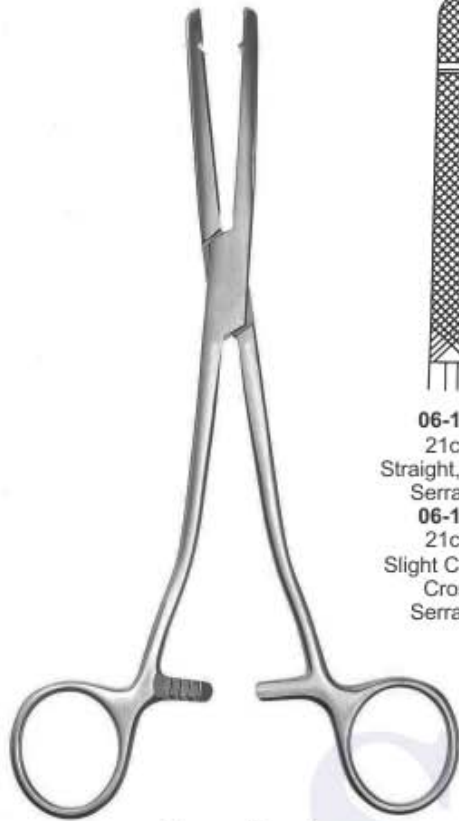

**Heaney / Rezak  
Haemostatic Forceps**

**06-178**  
21cm  
Straight, Cross  
Serrated  
**06-179**  
21cm  
Slight Curved,  
Cross  
Serrated



**Stille Haemostatic Forceps**  
**06-180** 23cm

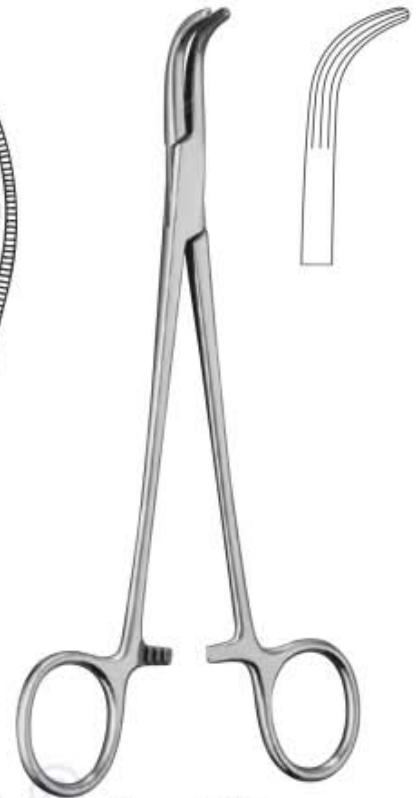

**Lower Haemostatic Forceps**  
**06-181** 18cm



**Lahey (Sweet)  
Haemostatic Forceps**

**06-182**  
19cm  
**06-183**  
22cm



**Desjardins Haemostatic  
Forceps**  
**06-184** 22cm



**Mixer Haemostatic  
Gall Duct Forceps**

**06-185**  
22cm

**06-186**  
25cm

**HAEMOSTATIC FORCEPS**

Arterienklemmen  
Pinces Hemostatiques

Pinzas Hemostaticas  
Pinze Emostatiche



**Mixer Forceps,  
06-188 18.4cm**  
Fully curved,  
original model

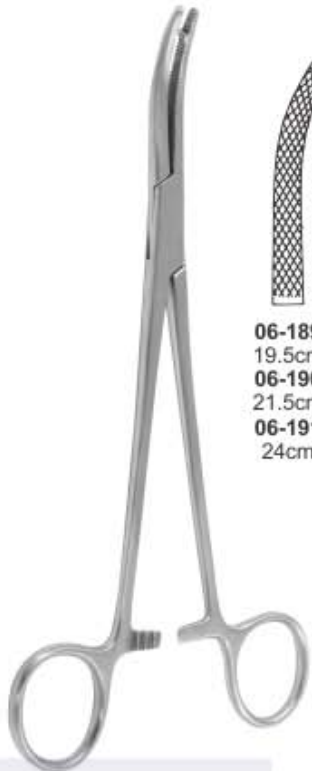

**06-189**  
19.5cm  
**06-190**  
21.5cm  
**06-191**  
24cm

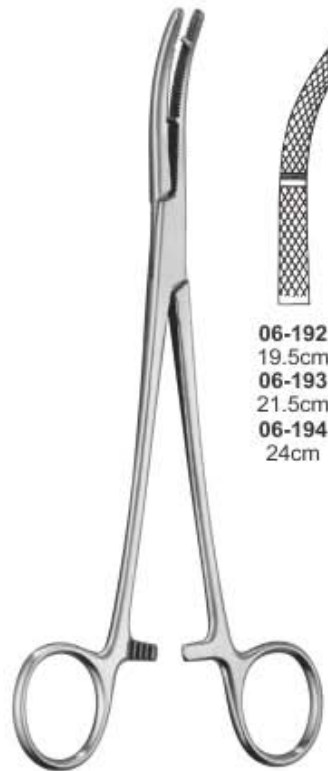

**06-192**  
19.5cm  
**06-193**  
21.5cm  
**06-194**  
24cm

**Mixer Forceps, Lee Modif  
06-187 13.3cm**  
Curved jaws and angled  
shanks, delicate

**Heaney Haemostatic Forceps**

**Heaney Modif. Haemostatic  
Forceps**

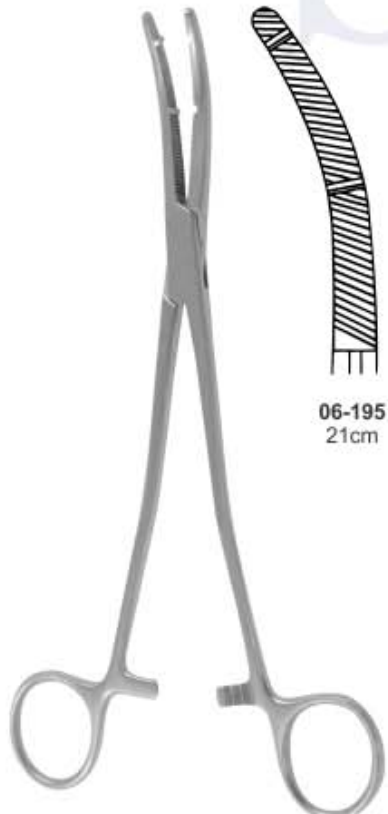

**06-195**  
21cm

**Heaney-Kanter  
Haemostatic Forceps**

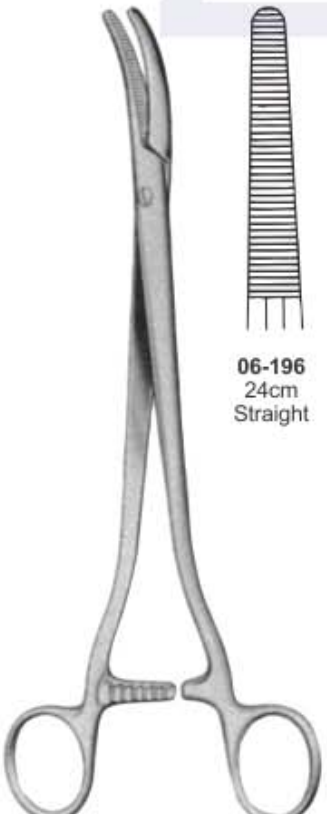

**06-196**  
24cm  
Straight

**06-197**  
24cm  
Curved

**Segond-Landau  
Haemostatic Forceps**

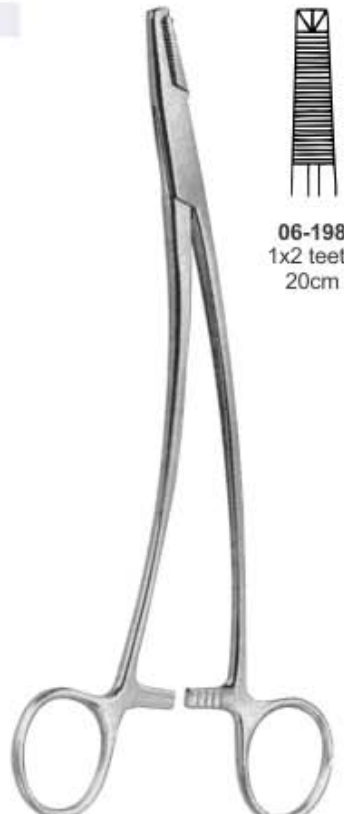

**06-198**  
1x2 teeth  
20cm

**Schindler Haemostatic Tissue  
Forceps**

# HAEMOSTATIC FORCEPS

Arterienklemmen  
Pincas Hemostatiquas

Pinzas Hemostaticas  
Pinze Emostatiche

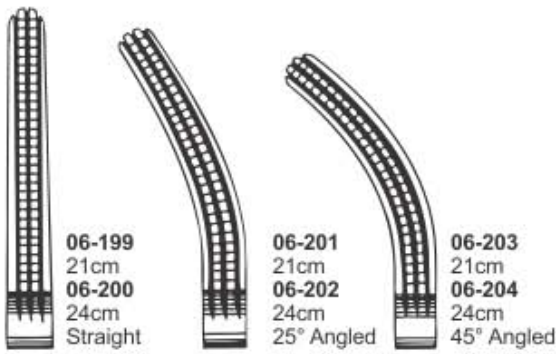
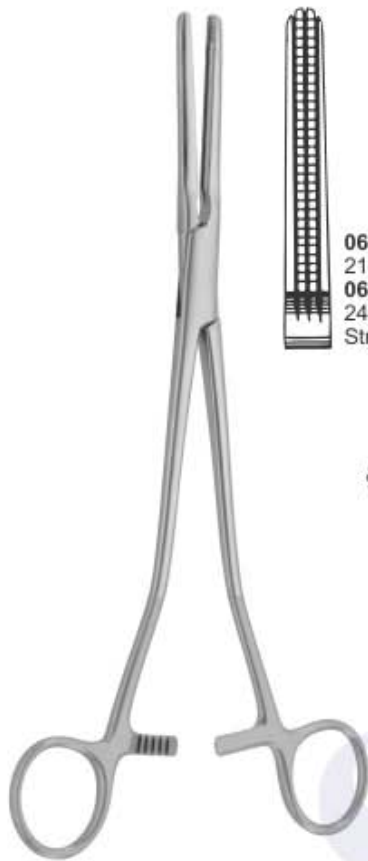

Parametrium Haemostatic Forceps

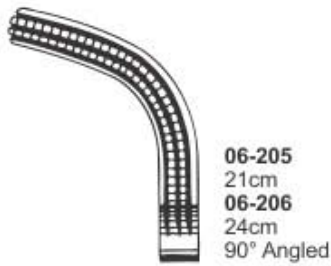

**06-207**  
26cm  
Curved  
Serrated

Bozemann Haemostatic Forceps



**06-208**  
26cm  
Straight

Bozemann Haemostatic Forceps



**06-209**  
23cm  
Straight

Westermark Haemostatic Forceps



**06-210**  
1x2 teeth  
21.5cm  
Straight

**06-211**  
1x2 teeth  
21.5cm  
Hard Curved

Phaneuf Haemostatic Tissue Forceps



**06-212**  
1x2 teeth  
19cm  
Curved

**06-213**  
1x2 teeth  
19cm  
Straight

Long Haemostatic Tissue Forceps

Arterienklemmen  
Pincas Hemostatiques

Pinzas Hemostaticas  
Pinze Emostatiche



**Baby-Mikulicz Haemostatic Tissue Forceps**



**Mikulicz Haemostatic Tissue Forceps**



**Mikulicz Haemostatic Tissue Forceps**



**Mikulicz Haemostatic Tissue Forceps**



**Mikulicz Haemostatic Tissue Forceps**



**Faure Haemostatic Tissue Forceps**

# HAEMOSTATIC FORCEPS

Arterienklemmen  
Pinces Hemostatiques

Pinzas Hemostaticas  
Pinze Emostatiche



**06-220**  
1x2 teeth  
23.5cm

Wertheim Haemostatic Tissue Forceps



**06-221**  
1x2 teeth  
24.5cm

Wertheim Haemostatic Tissue Forceps



**06-222**  
25.5cm

Wertheim Hysterectomy Forceps

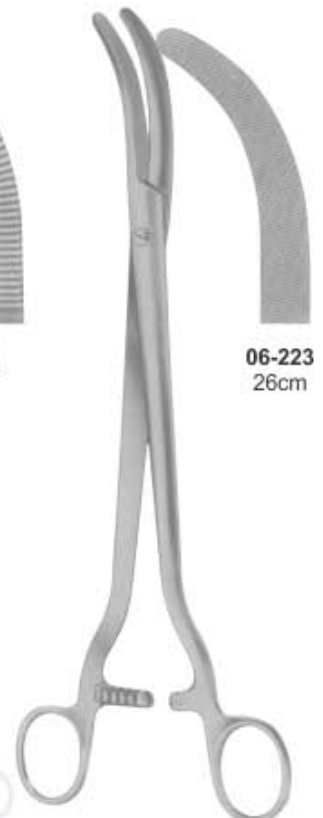

**06-223**  
26cm

Wertheim Parametrium Clamp



Heaney Atraumata Hysterectomy Forceps



Wertheim Parametrium Clamps



**HAEMOSTATIC FORCEPS**

Arterienklemmen  
Pincas Hemostatiques

Pinzas Hemostaticas  
Pinze Emostatiche



**Gemini Mixer Hemostatic Forceps**  
06-232 14cm  
06-233 17.75cm  
full curve, delicate



**Dick Haemostatic Forceps**



06-234 25.5cm  
06-235 26.5cm  
06-236 27.5cm

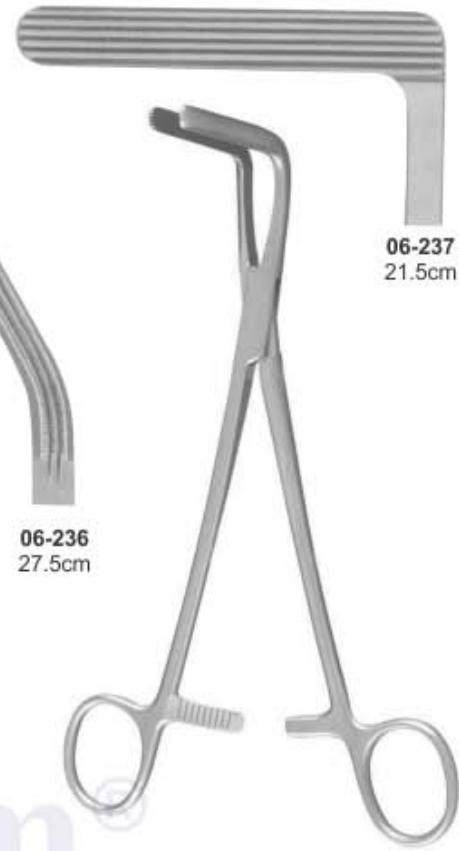

**Wertheim-Cullen Haemostatic Forceps**

06-237  
21.5cm



**Wertheim-Cullen Haemostatic Forceps**  
23cm

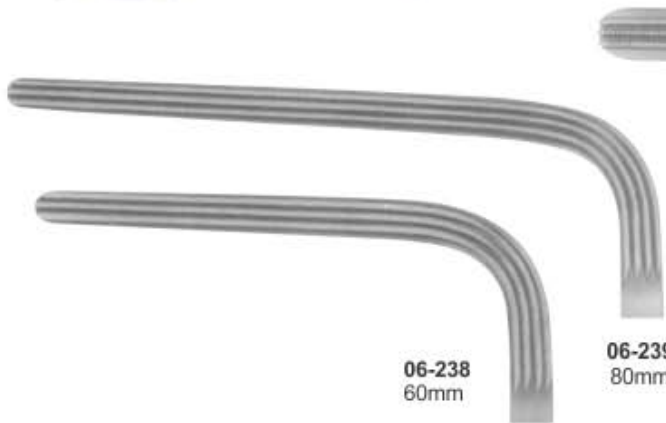

06-238 60mm  
06-239 80mm

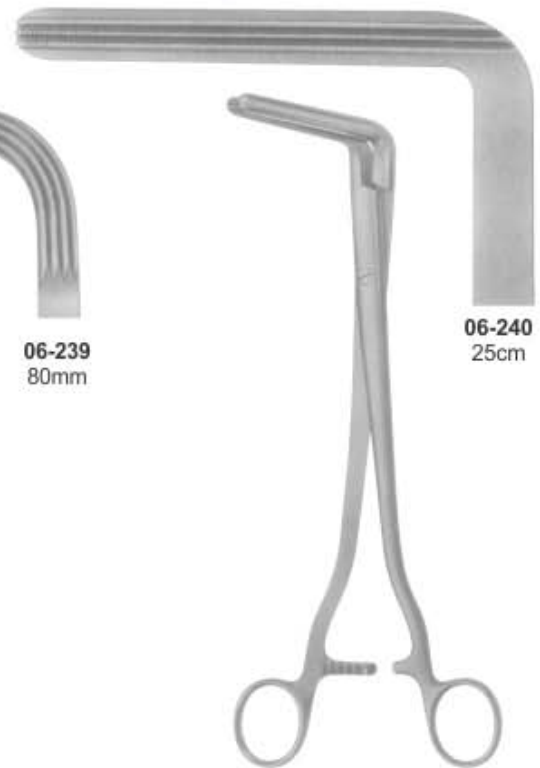

**Wertheim Haemostatic Forceps**

06-240  
25cm

# TOWEL FORCEPS

Tuchklemmen | Pincers à champs  
 Pinzas de campo | Pinze fissatele



**Jones / Perforating Towel Forceps** 06-241 9 cm Slight Curve  
**Jones-Martin Towel Clamp** 06-242 sharp 8.5 cm  
**Engl. Modell Towel Forceps** 06-243 9 cm  
**Schaedel Towel Forceps** 06-244 9 cm  
**Thomson-Walker's Penile Clamps** 06-245 9 cm Cross-Action model.  
**Doyen** 06-246 11cm  
**Doyen Towel Forceps** 06-247 18 cm  
**Fricke Artery Forceps** 06-248 13cm



06-249 8cm  
 06-250 11cm  
 06-251 13cm  
 06-252 15cm  
 Curved

**Backhaus Towel Forceps**  
**Backhaus Clip Towel Forceps** 06-253 11cm with clip for tubing or cable  
**Roeder Towel Forceps** 06-254 13cm 06-255 15cm Curved, Serrated  
**Lorna Towel Forceps** 06-256 9cm 06-257 11.4cm 06-258 13.5cm



**Ball & Socket Towel Forceps** 06-259 13cm Non-perforating  
**Tohoku Towel Forceps** 06-260 10cm 06-261 13cm Non-Perforating  
**Non-Perforating Towel Forceps** 06-262 11cm 06-263 13cm  
**Peers-Bertman Towel Forceps** 06-264 14.5cm Serrated



**HAEMOSTATIC FORCEPS**

Arterienklemmen  
Pincas Hemostatiques

Pinzas Hemostaticas  
Pinze Emostatiche



**Bernhard Towel Forceps**  
06-265 16.5cm

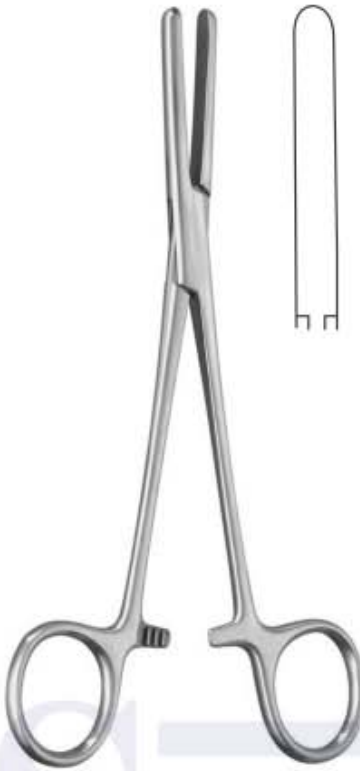

**Presbyterian Tubing Clamp**  
06-266 16.5cm  
06-267 18cm  
Straight, Smooth



**Tubing Clamp**  
06-268 18cm  
06-269 20cm  
Cross Serrated



**Klinikum Berlin Tubing Clamp**

06-270  
14.5cm  
with long  
ratchet

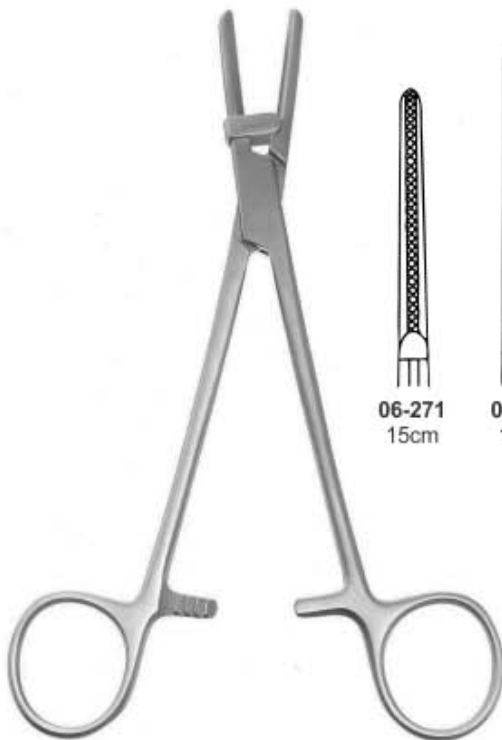

**Tubing Clamp with Protector**  
Cross Serrated

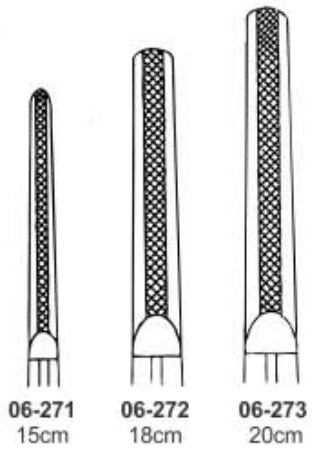

06-271 15cm  
06-272 18cm  
06-273 20cm

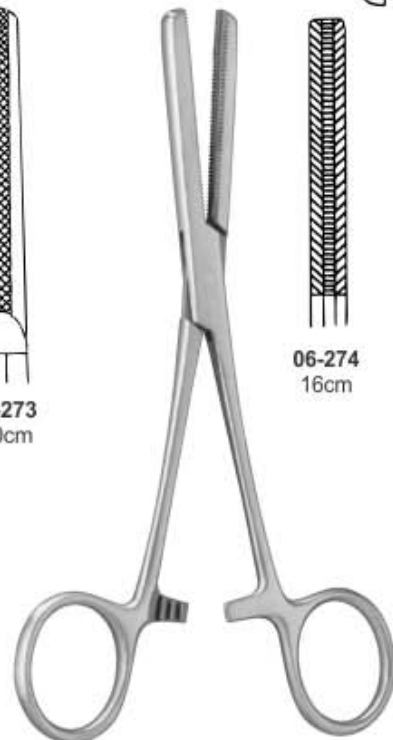

**Fergusson Tubing Clamp**

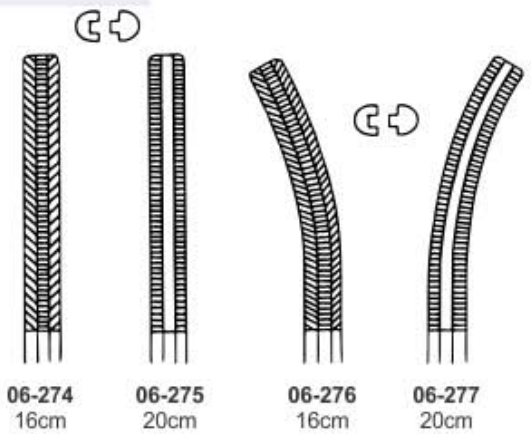

06-274 16cm  
06-275 20cm  
06-276 16cm  
06-277 20cm

# HAEMOSTATIC FORCEPS

Arterienklemmen  
Pinces Hemostatiques

Pinzas Hemostaticas  
Pinze Emostatiche



**Tuffier Haemostatic Forceps**  
06-278 13cm



**Chaput Haemostatic Forceps**  
06-279 13cm



**Pratt Haemostatic Forceps**  
06-280 15cm



**Pennington / Siezing Haemostatic Forceps**  
06-281 15.5cm  
06-282 20cm  
Straight



**Martel Haemostatic Forceps**  
06-283 14cm

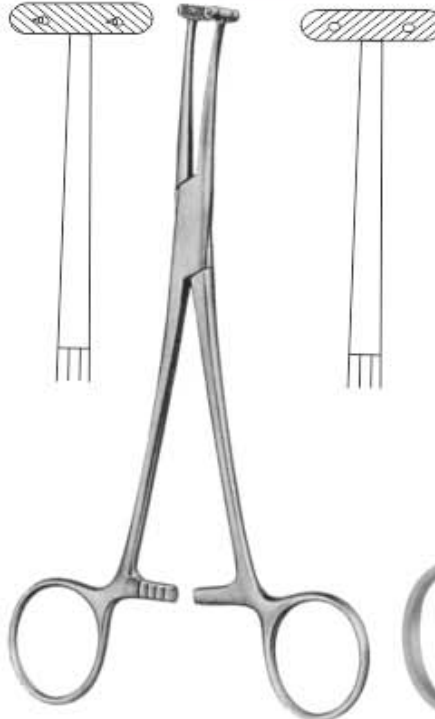

**Willet-Martel Haemostatic Forceps**  
06-284 19cm

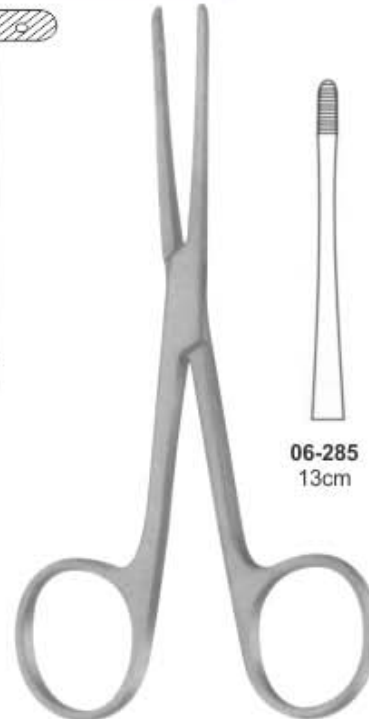

**Lister Sinus Forceps**



**06-285**  
13cm

**06-286**  
15.5cm

**06-287**  
17.5cm

**HAEMOSTATIC FORCEPS**

Arterienklemmen

Pinzas Hemostaticas

Pinces Hemostatiques

Pinze Emostatiche



**06-288**  
12.5cm

**06-289**  
14cm

**Collin Dressing  
Haemostatic Forceps**

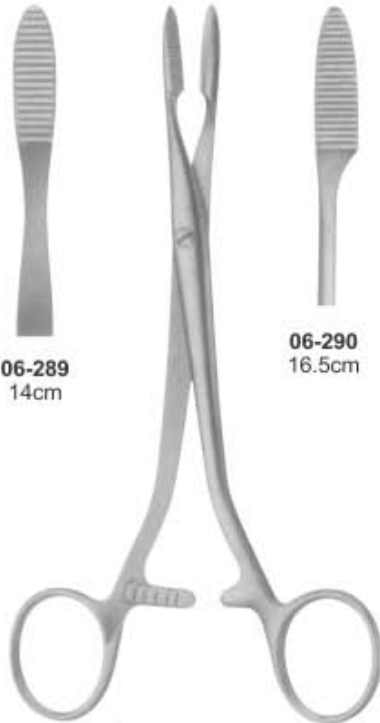

**06-290**  
16.5cm

**06-291**  
18.5cm

**Colling Dressing  
Haemostatic Forceps**

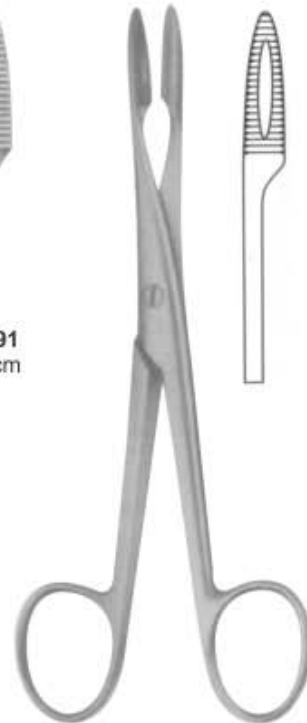

**Gross Maier Dressing Forceps**  
**06-292** 14.5cm straight  
Without Ratchet

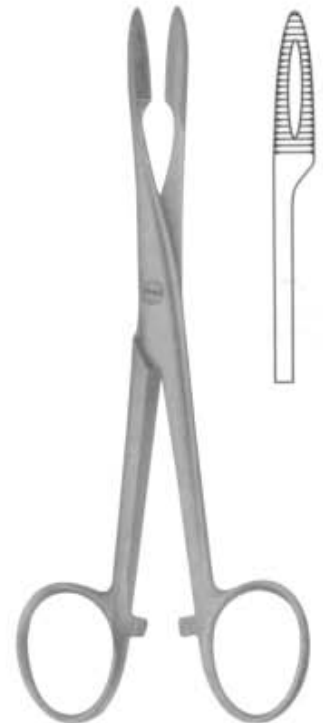

**Gross Maier Dressing Forceps**  
**06-293** 14.5cm straight  
With Ratchet



**Gross Maier Dressing Forceps**  
**06-294** 14.5cm, curved  
With Ratchet

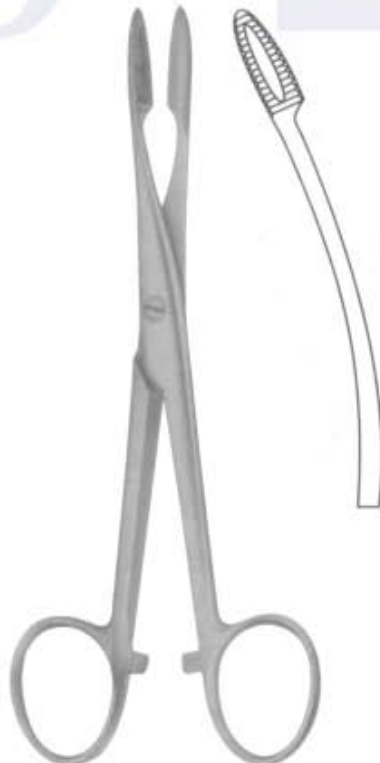

**Gross Maier Dressing Forceps**  
**06-295** 14.5cm, curved  
With Ratchet

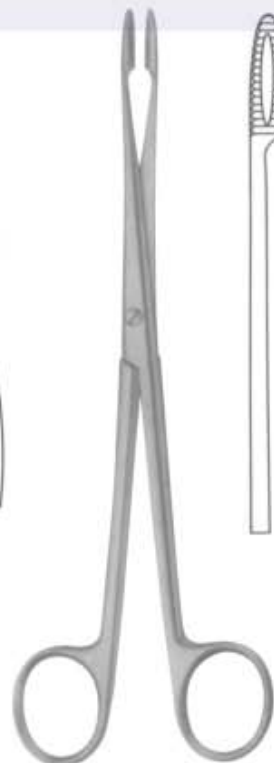

**Gross Maier Dressing  
Sponge & Dressing Forceps**  
**06-296** 20.5cm, straight  
Without Ratchet

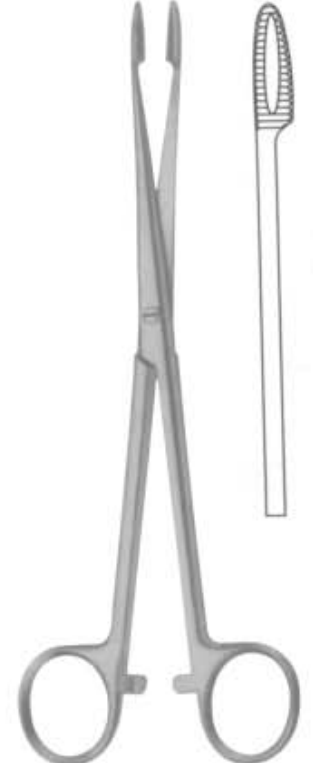

**Gross Maier Dressing  
Sponge & Dressing Forceps**  
**06-297** 17.8cm, straight  
With Ratchet

Arterienklemmen  
Pinces Hemostatiques

Pinzas Hemostaticas  
Pinze Emostatiche

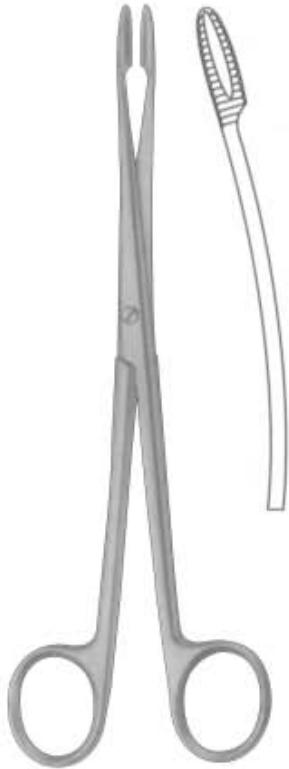

**Gross Maier Dressing  
Sponge & Dressing Forceps**  
**06-298** 20.5cm, curved  
Without Ratchet  
(bullet holding forceps)

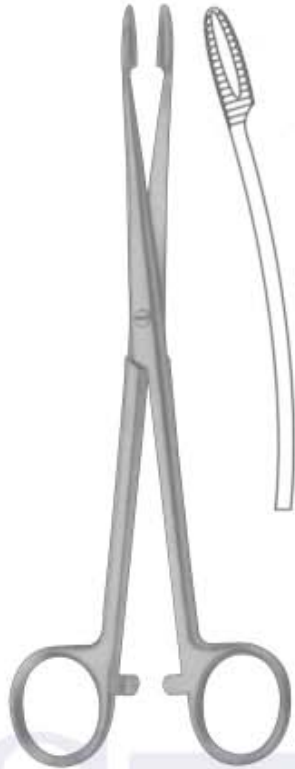

**Gross Maier Dressing  
Sponge & Dressing Forceps**  
**06-299** 17.8cm, curved  
With Ratchet



**Gross Maier Dressing Forceps**  
**06-300** 26.5cm, straight  
Without Ratchet  
(bullet holding forceps)



**Gross Maier Dressing Forceps**  
**06-301** 26.5cm, straight  
With Ratchet  
(bullet holding forceps)



**Gross Maier Dressing Forceps**  
**06-302** 26.5cm, curved  
Without Ratchet  
(bullet holding forceps)

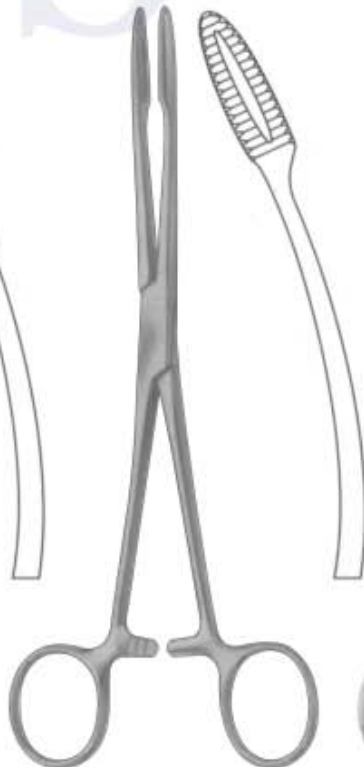

**Gross Maier Dressing Forceps**  
**06-303** 26.5cm, curved  
With Ratchet  
(bullet holding forceps)



**Collin Sponge &  
Dressing Forceps**

**06-304**  
24cm

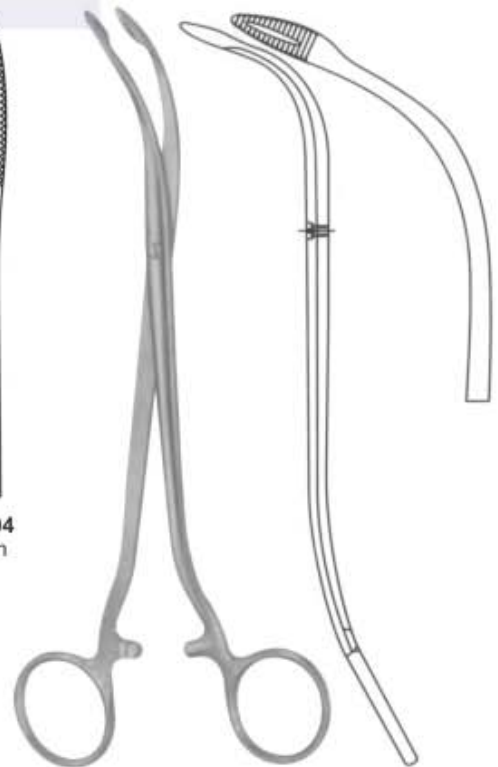

**Duplay Sponge &  
Dressing Forceps**  
**06-305** 19cm  
Slight Curve

Arterienklemmen

Pinzas Hemostaticas

Pinces Hemostatiques

Pinze Emostatiche

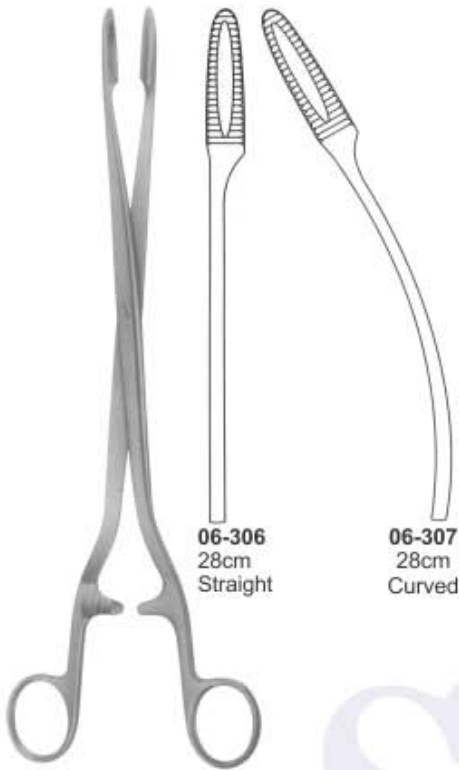

**Sims-Maier Sponge & Dressing Forceps**

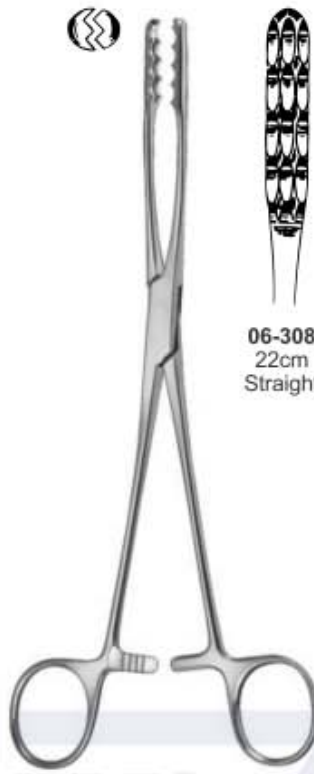

**Ulrich Sponge Forceps**

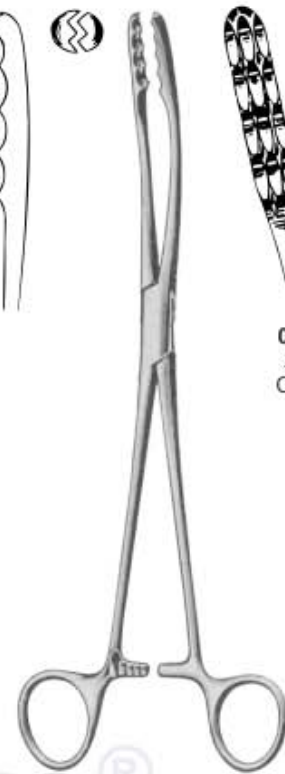
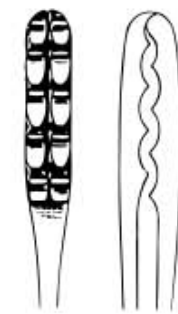

**Ulrich Sponge Forceps**



**Aesculap Sponge & Dressing Forceps**

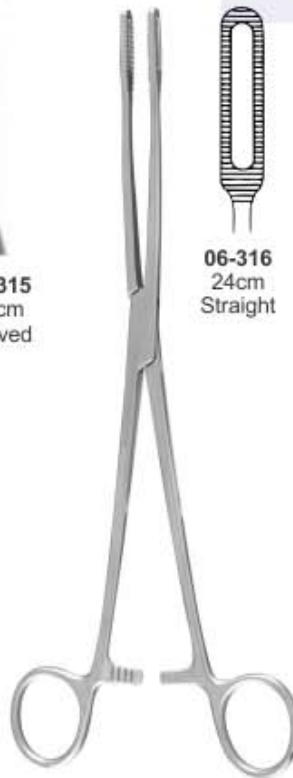

**Fletcher Sponge Forceps**



**Fletcher Sponge Forceps**



**Pelkmann Sponge Forceps**

# HAEMOSTATIC FORCEPS

Arterienklemmen

Pinzas Hemostaticas

Pinces Hemostatiques

Pinze Emostatiche

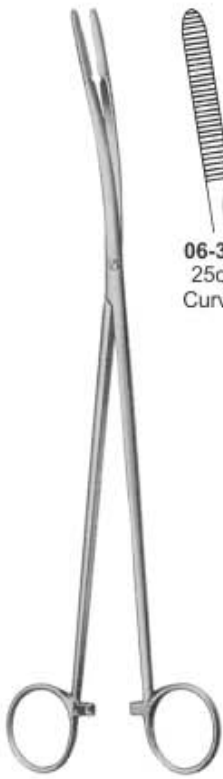

**06-319**  
25cm  
Curved

**Pelkmann Sponge Forceps**

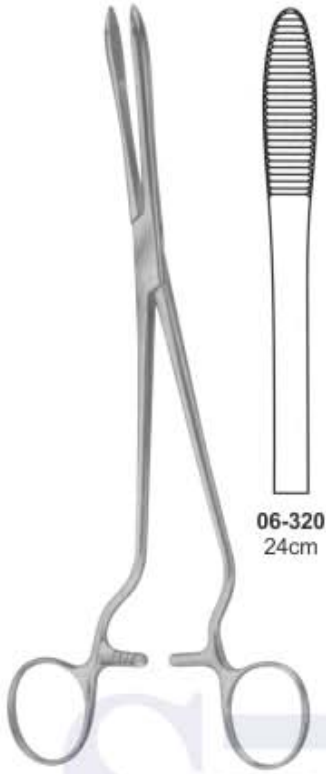

**06-320**  
24cm

**Cheron Forceps**  
Handles Laterally Angled



**06-321**  
20.5cm  
Straight

**Duplay Sponge Forceps**



**06-322**  
20.5cm  
Curved

**Duplay Sponge Forceps**



**Heywood Smith Sponge Forceps**  
**06-323** 25cm

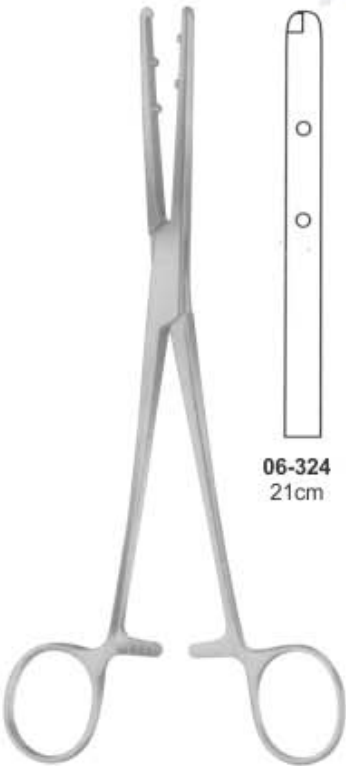

**06-324**  
21cm

**Emmet Sponge & Dressing Forceps**



**Tendon Seizing Forceps**



**06-325**  
15.5cm

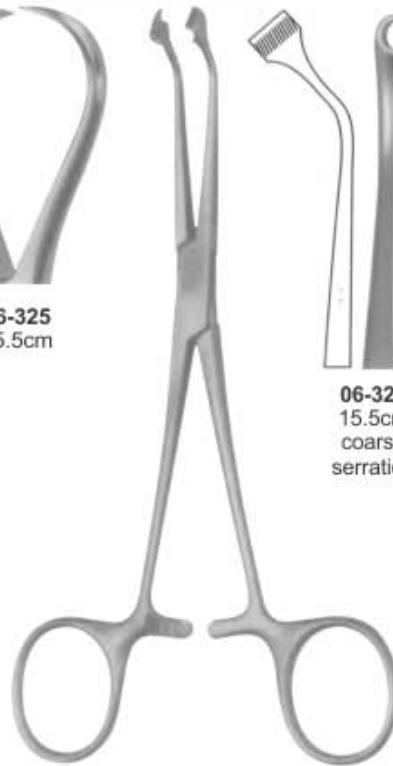

**Herz Tendon Seizing Forceps**

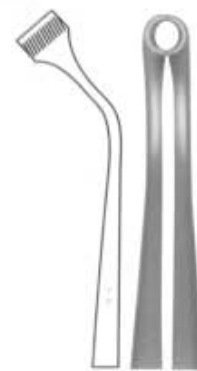

**06-326**  
15.5cm  
coarse  
serration



**06-327**  
15.5cm  
fine  
serrations

Arterienklemmen

Pinzas Hemostaticas

Pinces Hemostatiques

Pinze Emostatiche



**Noto Sponge & Dressing Forceps**  
06-328 28cm

**Kelly Sponge & Dressing Forceps**

**06-329**  
32cm  
Curved

**06-330**  
32cm  
Straight

**Heywood-Smith Sponge & Dressing Forceps**  
06-331 20cm

**Collin Sponge & Dressing Forceps**

**06-332**  
16cm  
**06-333**  
17cm

**06-334**  
16cm

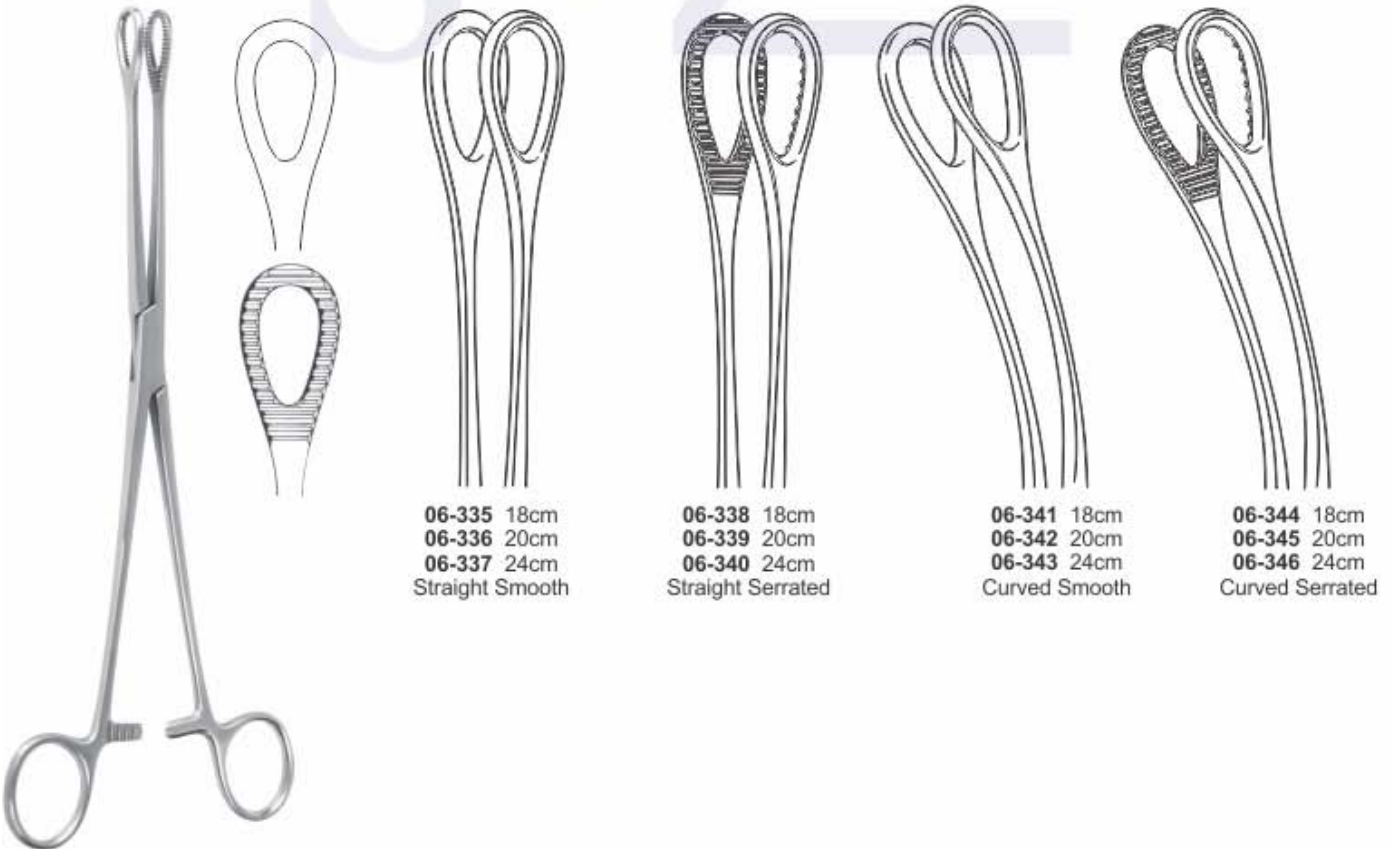

**06-335** 18cm  
**06-336** 20cm  
**06-337** 24cm  
Straight Smooth

**06-338** 18cm  
**06-339** 20cm  
**06-340** 24cm  
Straight Serrated

**06-341** 18cm  
**06-342** 20cm  
**06-343** 24cm  
Curved Smooth

**06-344** 18cm  
**06-345** 20cm  
**06-346** 24cm  
Curved Serrated

**Foerster-Ballenger Sponge Forceps & (bullet holding forceps)**